

# ASSEMBLY AND INSTALLATION INSTRUCTIONS

T0473 T0474

**WARNING:** TO AVOID RISK OF ELECTRICAL SHOCK, BE SURE TO SHUT OFF POWER WHILE INSTALLING OR SERVICING THIS FIXTURE.

**NOTE:** 1. Before installing, consult local electrical codes for wiring and grounding requirements.  
2. READ AND SAVE THESE INSTRUCTIONS.

## Hardware Package (included):

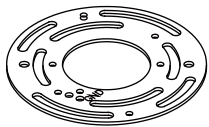

Mounting plate (A)



Mounting Screw (B)

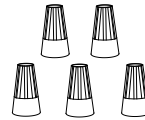

Wire Connector (C)

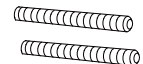

Headless screw (D)



Green Grounding Screw (E)



Lock Nut (F)



Ball Nut (G)



Rubber Pad (H)

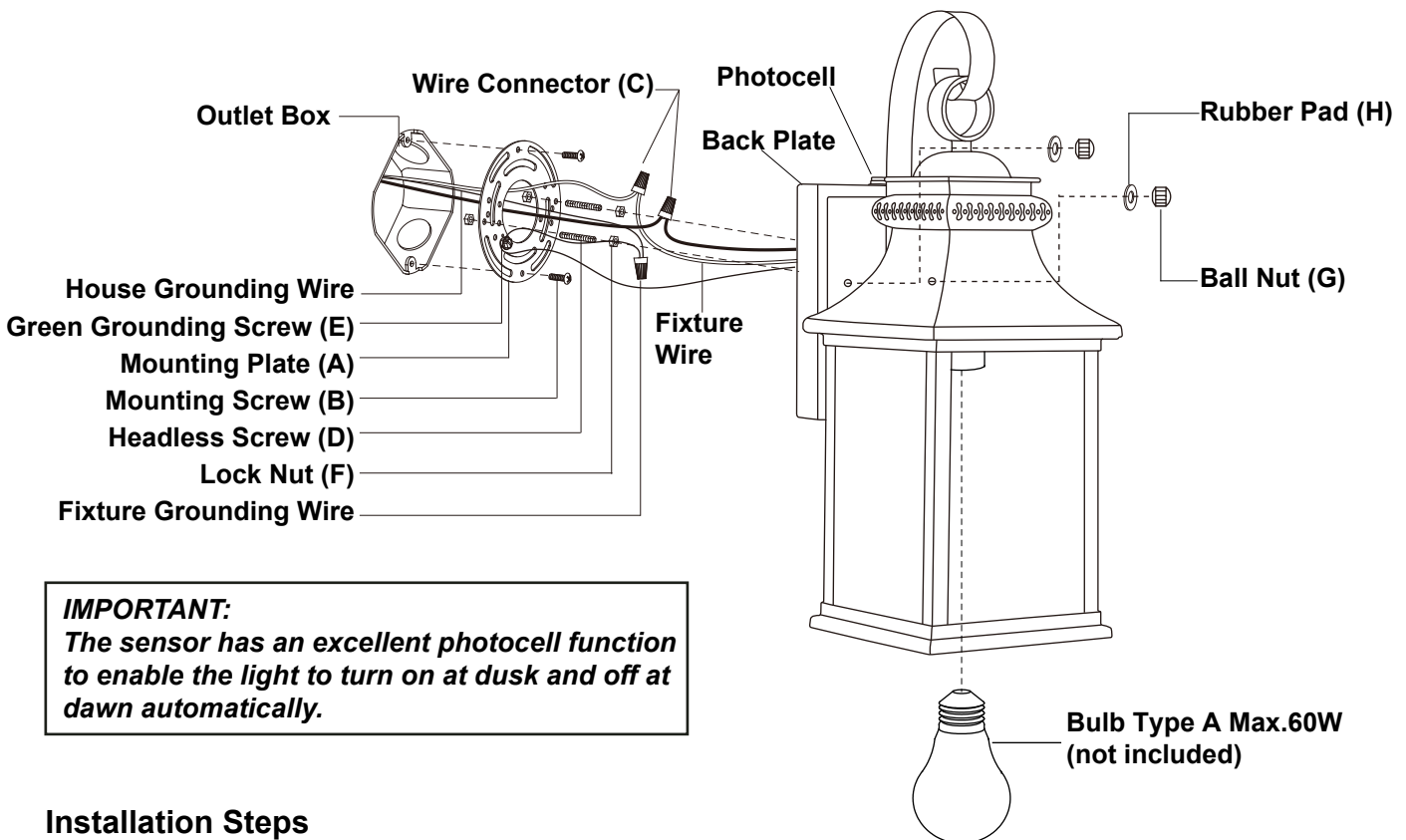

### IMPORTANT:

The sensor has an excellent photocell function to enable the light to turn on at dusk and off at dawn automatically.

## Installation Steps

Turn off the power at fuse or circuit box

1. Thread two headless screws (D) through the mounting plate (A), and then secure them with four lock nuts (F) (two on each side of the mounting plate (A).) Adjust the length of the headless screws (D) if necessary.  
**Note: Make sure the headless screws are lined up horizontally to make the fixture level.**
2. Attach the mounting plate (A) to the outlet box by using two mounting screws (B).

3. Make the bottom of the fixture upward, gently place four glass panels into the metal frame, then press the clips to secure the glass panels. (Fig.1)

**Note: The patterned side of glass faces out .**

4. Pull out the source wires from the outlet box. Make wire connections using wire connectors (C) as follows:

- Connect the hot wire (usually black insulation) from the fixture to the black wire from the power source.
  - Connect the neutral wire (usually white insulation) from the fixture to the white wire from the power source.
  - Attach the fixture grounding wire (usually green insulation or bare wire) to the mounting plate (A) with the green grounding screw (E), and then connect it to the house grounding wire with the wire connector (C).
- Carefully put the wires back into the outlet box.

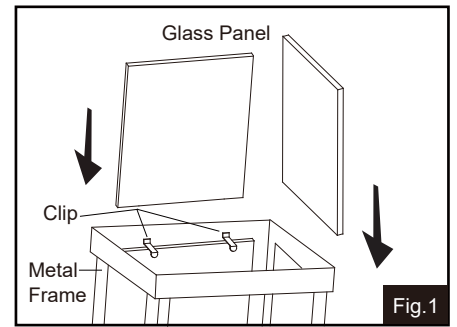

5. Attach the fixture to the mounting plate (A) by inserting headless screws (D) into holes on back plate, and then secure it with two rubber pads (H) and two ball nuts (G).

**NOTE: With silicone caulking compound,caulk complete around the back plate meets with the wall surface to prevent water from seeping into the outlet box.**

6. Install a bulb (not included). See relamping label at socket area or packaging for maximum allowed wattage.

Turn on the power at fuse or circuit box

## Operation the Unit Without Photocell

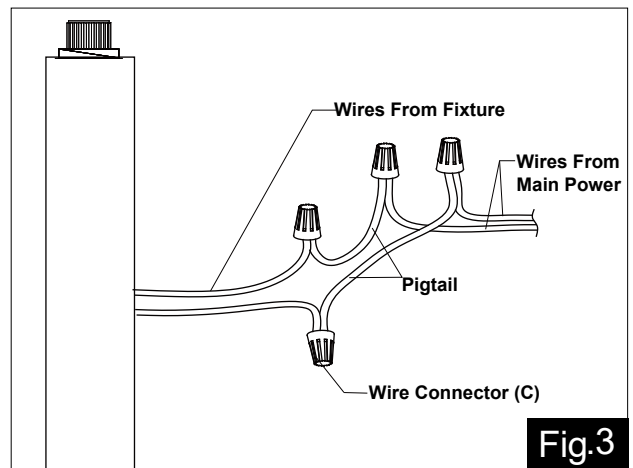
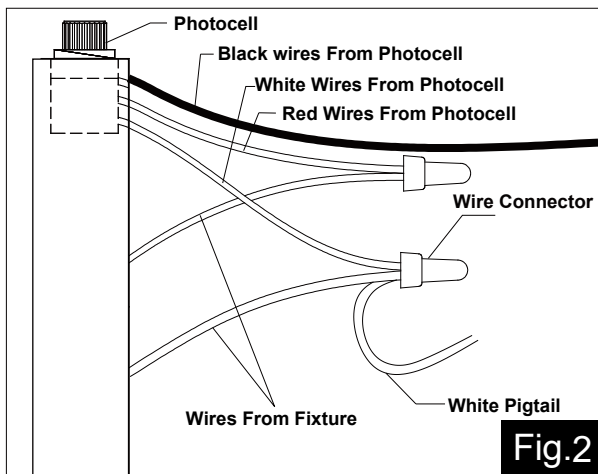

1. Turn off the power at the fuse or circuit box before starting installation.

2. Loosen the wire connector connected with the wires from photocell. (See Fig.2)

**Note: Do not move the photocell to prevent water from seeping into the outlet box.**







3. Take a white pigtail and black pigtail and make wire connections using wire connector (C): (See Fig.3)

- a. The black wire from the fixture to one end of the black pigtail.
  - b. The white wire from the fixture to one end of the white pigtail.
  - c. The other end of the black pigtail to the black wire from the power source.
  - d. The other end of the white pigtail to the white wire from the power source.
- Put all wires back into the back plate of the fixture.

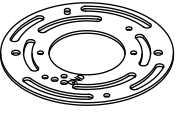
Turn on the power at fuse or circuit box.

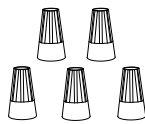
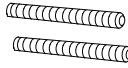
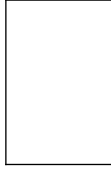
The following parts are available for re-order if damaged or missing.

**Spare Parts List:**

				<p>Mounting Hardware 6061MM (1SET)</p>  <p>Glass Panel 10083W for T0473 10076W for T0474</p>
Mounting plate (A)	Mounting Screw (B)	Wire Connector (C)	Headless screw (D)	
				
Green Grounding Screw (E)	Lock Nut (F)	Ball Nut (G)	Rubber Pad (H)	

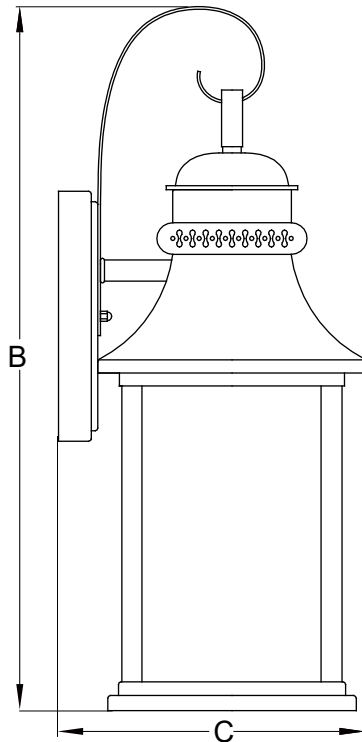
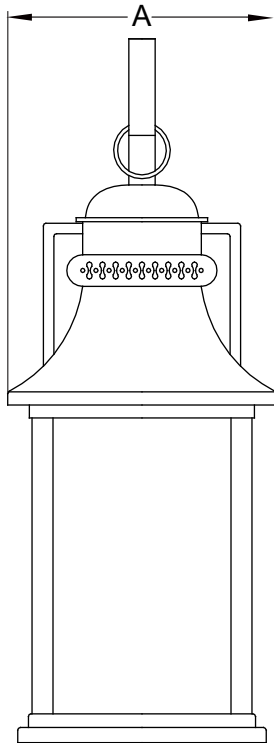

**T0473**

**T0474**

**A: 6"**

**A: 8"**

**B: 16-1/4"**

**B: 21"**

**C: 7-1/4"**

**C: 9-1/4"**